

Wandventilator DHCAW Flachbauweise

Wandventilatoren für einfache Entlüftung von z.B. Räumen, Industriehallen, Kompressorräumen, Pumpenräumen, Kellern, Containern

Ventilator:

- Wandplatte aus Stahl verzinkt beschichtet
- Laufrad aus Stahlblech (bis 300-4M), Kunststoff (315-2M bis 355) oder Aluguss (ab Baugröße 450)
- Saugseitig mit Schutzgitter. Ab Baugröße 710 Zubehörteil



Motor:

- Motoren 230 Volt drehzahlsteuerbar durch Spannungsabsenkung mit Thyristor oder Transformator
- Motoren 400 V 2-stufig schaltbar, steuerbar mit Transformator oder frequenzregelbar mit allpolig wirksamen Sinusfilter
- Motorschutz vor Überhitzung mittels Zubehörteil externes Motorschutzschaltgerät

Auf Anfrage:

- Für Ventilator-Motoren mit Sonder-Spannungen und/oder ATEX bitte unsere Baureihe DHC mit Industrie-Normmotoren betrachten.

Wandventilatoren DHCAW 230 Volt

Wandventilator	Drehzahl U/min	Nennstrom A	Leistungs- aufnahme max. W	Schutzart	Luftmenge max. m³/h	Gewicht kg	Wand- einschub Ø mm	Wandplatte quadratisch mm x mm
DHCAW-20-2M-C	2414	0,26	57	IP54	780	3	210	310x310
DHCAW-20-4M-C	1434	0,2	42	IP54	410	2	210	310x310
DHCAW-25-2M-C	2095	0,48	106	IP54	1510	4,5	280	370x370
DHCAW-25-4M-C	1399	0,25	53	IP54	820	3,5	280	370x370
DHCAW-30-2M	2730	1,35	309	IP54	3413	6,2	326	430x430
DHCAW-30-4M-C	1386	0,43	91	IP54	1540	5,5	325	430x430
DHCAW-31-4M	1228	0,66	145	IP44	2117	5,7	345	430x430
DHCAW-35-4M-K	1070	0,56	130	IP54	2860	7,5	390	485x485
DHCAW-40-4M	1350	1,06	241	IP54	3863	8,7	420	540x540
DHCAW-45-4M	1393	2,88	607	IP54	7301	16,2	480	575x575
DHCAW-50-4M	1237	3,2	727	IP54	8878	20	531	655x655
DHCAW-56-4M	1424	5,5	1157	IP54	11930	31,7	589	725x725
DHCAW-63-6M	916	2,8	609	IP54	10624	26,5	664	805x805
DHCAW-71-6M	852	4,32	950	IP54	13892	34	763	850x850

Wandventilatoren DHCAW 400 Volt

Wandventilator	Drehzahl U/min	Nennstrom A	Leistungs- aufnahme max. W	Schutzart	Luftmenge max. m³/h	Gewicht kg	Wand- einschub Ø mm	Wandplatte quadratisch mm x mm
DHCAW-31-4T	1364	0,28	112	IP44	2412	5,3	345	430x430
DHCAW-35-4T	1390	0,4	190	IP54	3500	7,6	388	485x485
DHCAW-40-4T	1372	0,44	223	IP54	3870	8,7	420	540x540
DHCAW-45-4T	1353	1,1	545	IP54	7196	14,6	480	575x575
DHCAW-50-4T	1290	1,76	770	IP54	9140	20,1	531	655x655
DHCAW-56-4T	1283	2,2	1044	IP54	11344	24	589	725x725
DHCAW-63-4T	1353	3,4	1935	IP54	15926	34,2	664	805x805
DHCAW-63-6T	903	1,26	629	IP54	11214	24,1	664	805x805
DHCAW-71-4T	1302	4,9	2646	IP54	22576	35	763	850x850
DHCAW-71-6T	914	2,46	1000	IP54	14594	34,2	763	850x850
DHCAW-80-6T	833	3,7	1648	IP54	22255	53	869	970x970
DHCAW-90-6T	884	4,5	1947	IP54	27583	58	922	1070x1070
DHCAW-100-6T	823	5,4	2728	IP54	36468	67	1016	1170x1170

Technische Änderungen vorbehalten

Abmessungen

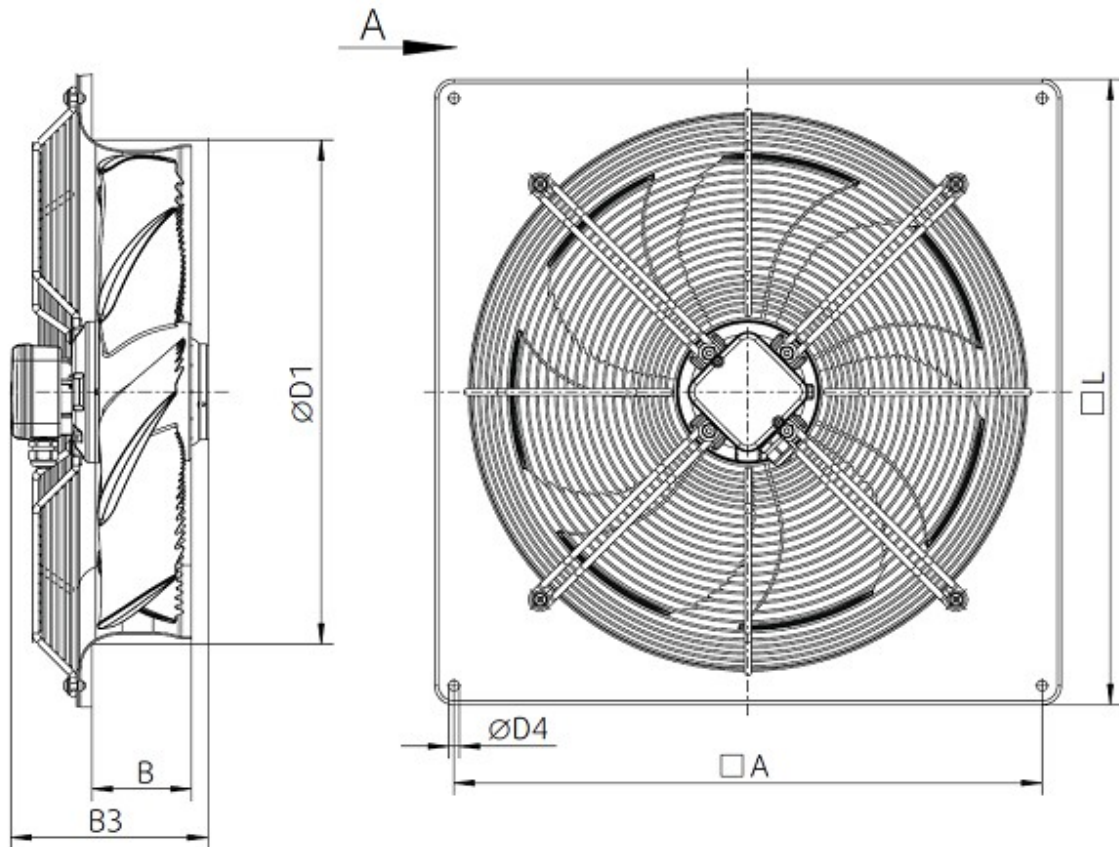

Modell	□A	B	B3	ØD1	ØD4	□L
DHCAW-20-2M-C	260	53	128	210	7	310
DHCAW-20-4M-C	260	53	128	210	7	310
DHCAW-25-2M-C	320	75	150	280	7	370
DHCAW-25-4M-C	320	75	150	280	7	370
DHCAW-30-2M	380	69	166	326	9	430
DHCAW-30-4M-C	380		156	325	9	430
DHCAW-31-4M	380	62	159	345	9	430
DHCAW-31-4T	380	62	162	345	9	430
DHCAW-35-4M-K	435	68	173	390	9	485
DHCAW-35-4T	435	68	182	388	9	485
DHCAW-40-4M	490	88	182	420	9	540
DHCAW-40-4T	490	88	182	420	9	540
DHCAW-45-4M	535	96	226	480	11	575
DHCAW-45-4T	535	96	226	480	11	575
DHCAW-50-4M	615	104	226	531	11	655
DHCAW-50-4T	615	104	226	531	11	655
DHCAW-56-4M	675	119	266	589	11	725
DHCAW-56-4T	675	119	245	589	11	725
DHCAW-63-6M	750	130	246	664	11	805
DHCAW-63-4T	750	130	271	664	11	805
DHCAW-63-6T	750	130	225	664	11	805
DHCAW-71-6M	810	150	272	763	14,5	850
DHCAW-71-4T	810	228	298	763	14,5	850
DHCAW-71-6T	810	150	272	763	14,5	850
DHCAW-80-6T	910	193	319	869	14,5	970
DHCAW-90-6T	1010	220	293	977	14,5	1010
DHCAW-100-6T	1110	250	323	1016	14,5	1170

Akustik

Schalleistungspegel Lw dB(A) und Schalldruckpegel Lp dB(A) in Abstand 1 Meter

Modell	Schalleistungspegel dB(A) über dem Oktavband (Hz)								Total	Schalldruck in Abstand 1m dB(A)
	63	125	250	500	1k	2k	4k	8k		
DHCAW-20-2M-C										52
DHCAW-20-4M-C										46
DHCAW-25-2M-C										60
DHCAW-25-4M-C										50
DHCAW-30-2M										71
DHCAW-30-4M-C										60
DHCAW-31-4M	44	50	50	51	54	53	48	38	60	59
DHCAW-31-4T	43	47	49	51	54	53	48	38	59	62
DHCAW-35-4M-K	<10	39	44	53	55	62	56	46	64	
DHCAW-35-4T	31	49	52	63	66	66	63	55	71	
DHCAW-40-4M	37	53	60	62	67	66	60	51	71	64
DHCAW-40-4T	36	54	57	62	67	66	61	51	71	64
DHCAW-45-4M	12	44	54	66	67	69	69	61	74	67
DHCAW-45-4T	41	56	59	64	68	69	64	56	73	67
DHCAW-50-4M	13	43	50	60	66	69	64	53	72	66
DHCAW-50-4T	39	59	59	65	70	69	65	55	74	67
DHCAW-56-4M	19	48	62	75	84	85	78	68	88	76
DHCAW-56-4T	23	50	57	68	75	77	73	62	80	74
DHCAW-63-6M	15	39	53	63	70	69	64	54	74	67
DHCAW-63-4T	15	46	57	70	78	78	73	64	82	78
DHCAW-63-6T	34	57	56	60	66	66	61	52	71	64
DHCAW-71-6M	46	60	64	65	68	68	63	55	73	67
DHCAW-71-4T	43	67	70	75	78	75	74	66	82	76
DHCAW-71-6T	45	55	61	65	69	67	61	52	45	66
DHCAW-80-6T	14	42	56	62	68	69	64	55	73	69
DHCAW-90-6T	57	63	70	74	74	70	67	57	79	72
DHCAW-100-6T	57	64	70	74	75	72	68	64	80	72

Akustik-Werte sind noch nicht vollständig und werden stetig aktualisiert.
Bei konkreter Anfrage bitte anfordern.

ERP Daten, Luftwerte bei bestem Wirkungsgrad,

Werte ohne Drehzahlregelung
Messkategorie statisch

Modell	Luftmenge Q (m ³ /h)	Effizienzgrad N	Effizienzgrad Ziel N	Drehzahl (U/min)	Druckerhöhung total (Pa)	Leistungsverbrauch (W)	Gesamtwirkungsgrad (%)	ERP ready
DHCAW-20-2M-C				ERP not relevant				Yes, ERP 2018
DHCAW-20-4M-C				ERP not relevant				Yes, ERP 2018
DHCAW-25-2M-C				ERP not relevant				Yes, ERP 2018
DHCAW-25-4M-C				ERP not relevant				Yes, ERP 2018
DHCAW-30-2M	2290	40,2	40	2570	140	280	30,4	Yes, ERP 2018
DHCAW-30-4M-C				ERP not relevant				Yes, ERP 2018
DHCAW-31-4M				ERP not relevant				Yes, ERP 2018
DHCAW-31-4T				ERP not relevant				Yes, ERP 2018
DHCAW-35-4M-K				ERP not relevant				Yes, ERP 2018
DHCAW-35-4T	2319	40	40	1396	80	180	29,3	Yes, ERP 2018
DHCAW-40-4M	2414	41,3	40	1354	101	240	31,1	Yes, ERP 2018
DHCAW-40-4T	2647	43,6	40	1367	98	230	33,2	Yes, ERP 2018
DHCAW-45-4M	7300	41,8	40	1398	140	590	34	Yes, ERP 2018
DHCAW-45-4T	4605	42	40	1365	140	540	34	Yes, ERP 2018
DHCAW-50-4M	5735	40,3	40	1253	134	700	32,9	Yes, ERP 2018
DHCAW-50-4T	5638	40,7	40	1285	148	710	33,4	Yes, ERP 2018
DHCAW-56-4M	8222	41,8	40	1428	170	1100	35,8	Yes, ERP 2018
DHCAW-56-4T	7424	40,1	40	1300	158	990	33,7	Yes, ERP 2018
DHCAW-63-6M	6958	45,6	40	923	106	570	37,7	Yes, ERP 2018
DHCAW-63-4T	11367	45,5	40	1377	212	1770	40,7	Yes, ERP 2018
DHCAW-63-6T	7166	41,6	40	908	100	600	33,8	Yes, ERP 2018
DHCAW-71-6M	8834	42	40	881	117	840	35,2	Yes, ERP 2018
DHCAW-71-4T	13327	41,7	40	1339	257	2570	37,9	Yes, ERP 2018
DHCAW-71-6T	9988	44	40	925	119	910	37,4	Yes, ERP 2018
DHCAW-80-6T	13370	40,6	40	860	154	1650	35,7	Yes, ERP 2018
DHCAW-90-6T	16357	45,4	40	888	165	1880	40,8	Yes, ERP 2018
DHCAW-100-6T	22250	40,5	40	830	153	2630	36,8	Yes, ERP 2018

Kennlinien

DHCAW-20-2M-C

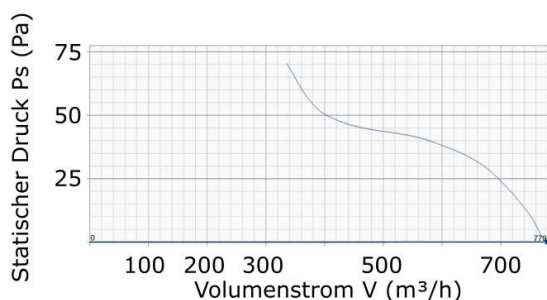

DHCAW-20-4M-C

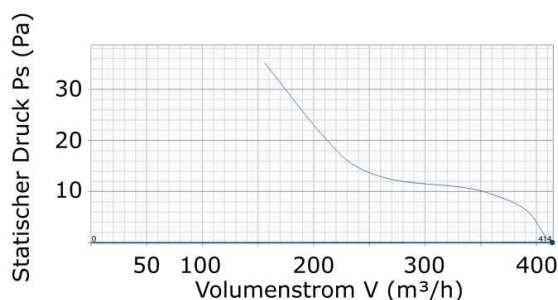

DHCAW-25-2M-C

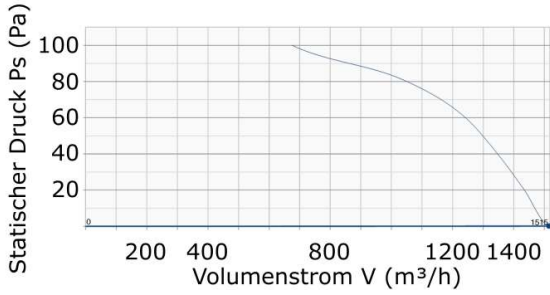

DHCAW-25-4M-C

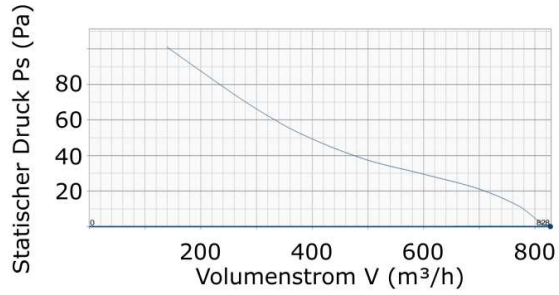

DHCAW-30-2M

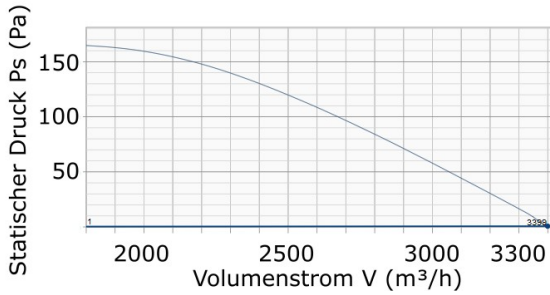

DHCAW-30-4M-C

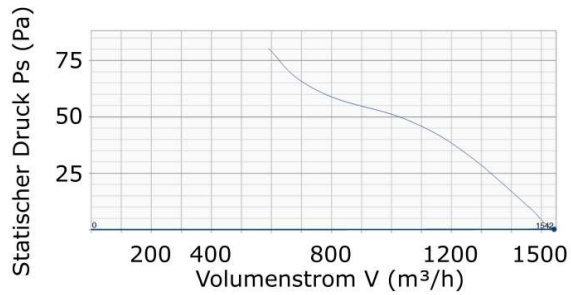

DHCAW-31-4M

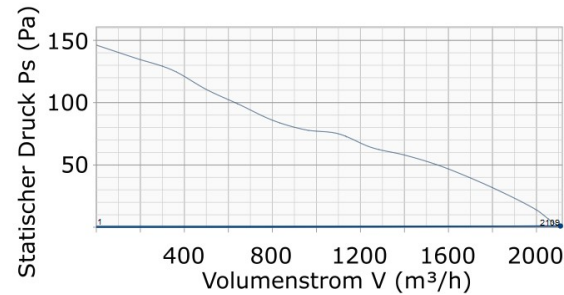

DHCAW-31-4T

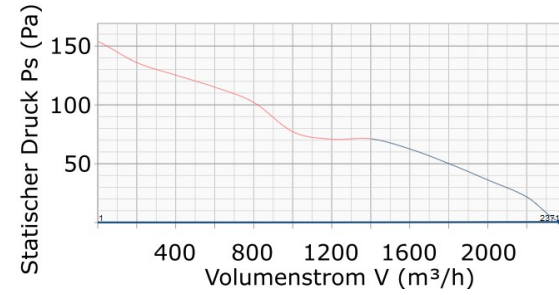

DHCAW-35-4M-K

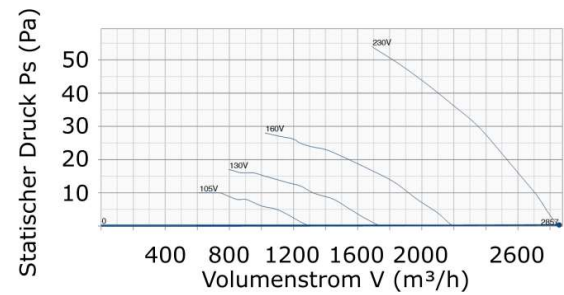

DHCAW-35-4T

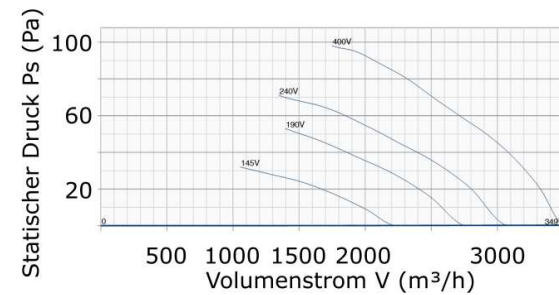

DHCAW-40-4M

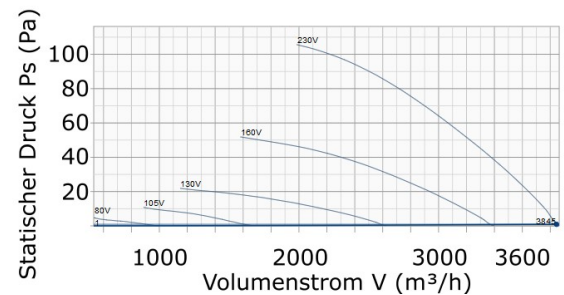

DHCAW-40-4T

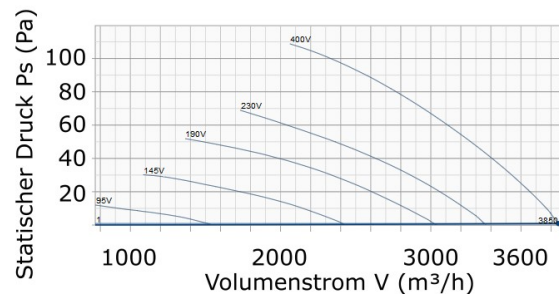

DHCAW-45-4M

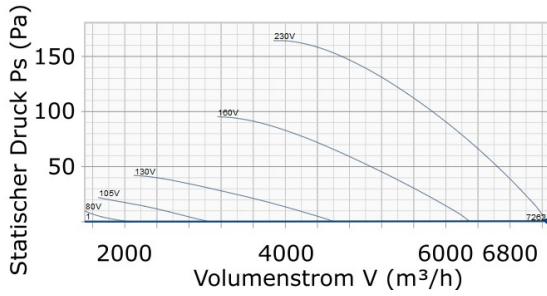

DHCAW-45-4T

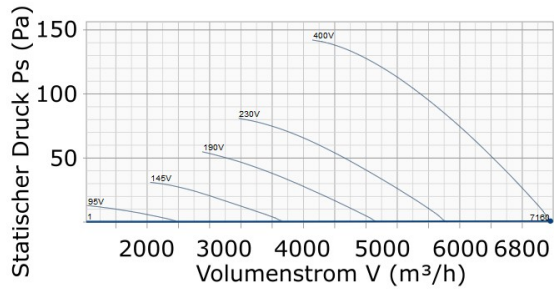

DHCAW-50-4M

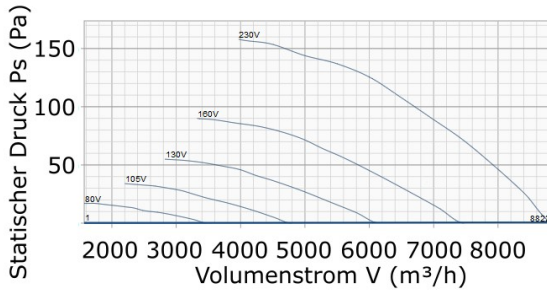

DHCAW-50-4T

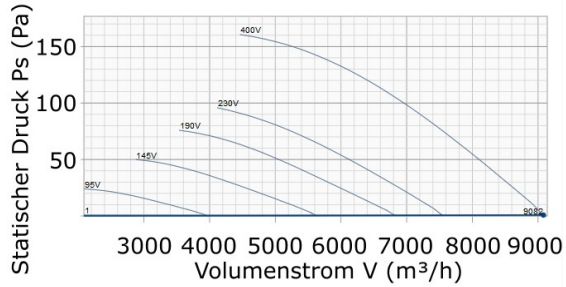

DHCAW-56-4M

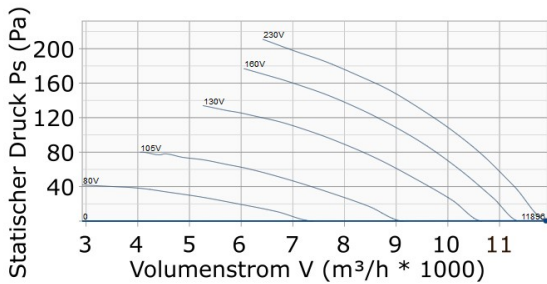

DHCAW-56-4T

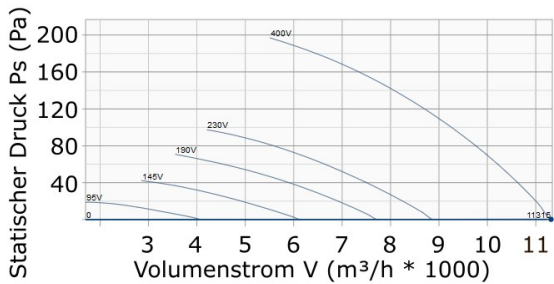

DHCAW-63-4T

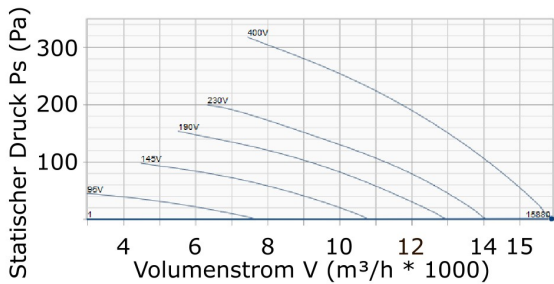

DHCAW-63-6M

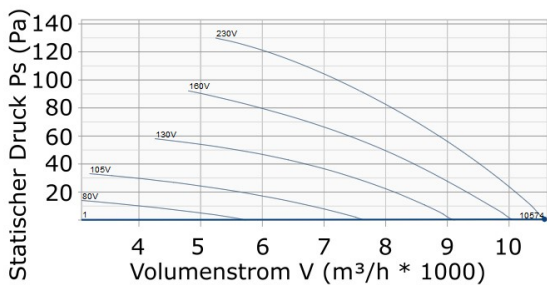

DHCAW-63-6T

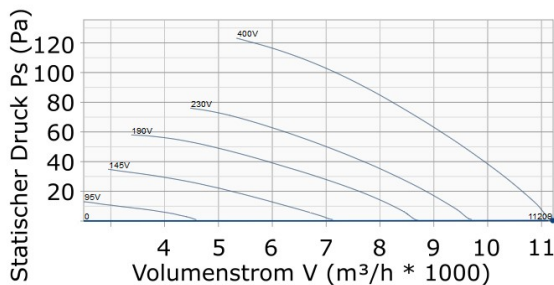

DHCAW-71-4T

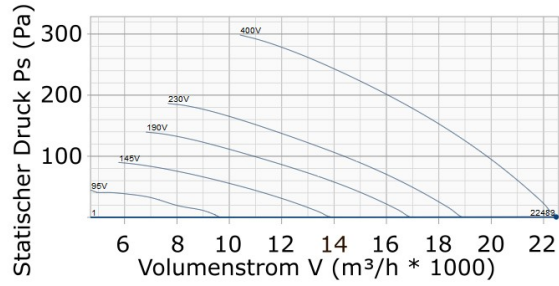

DHCAW-71-6M

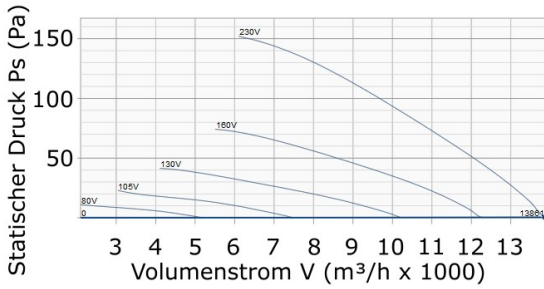

DHCAW-71-6T

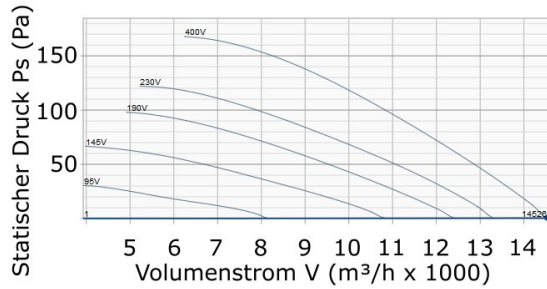

DHCAW-80-6T

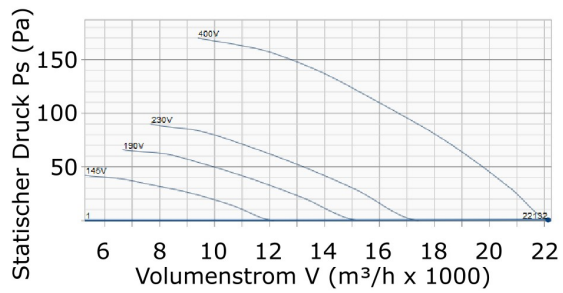

DHCAW-90-6T

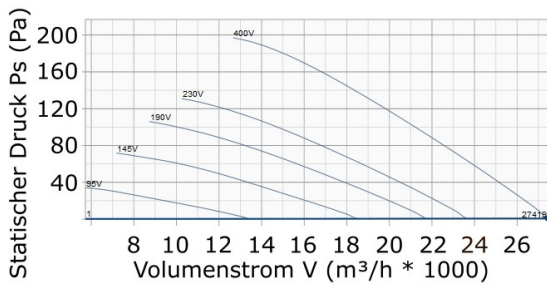

DHCAW-100-6T

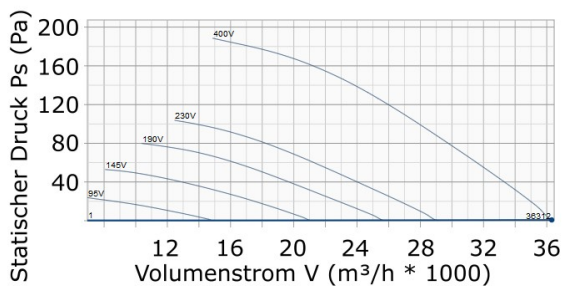

Zubehör

- Schutzgitter
- Motorschutzschalter
- Raumthermostat
- Ausblas-Abluftklappen (selbsttätig oder motorisch 230V, Kunststoff oder Aluminium)

Ausblas Abluftklappen Wetterschutz

Type DWSK aus Kunststoff langlebig und UV-beständig. Klappe selbsttätig durch Luftstrom öffnend. Bei Drehzahlregelung besser motorische Klappen (Type DWMK) einsetzen.

Wandventilator	Drehzahl	Wand- einschub	Abluftklappe quadratisch		
	U/min	Ø mm	Modell	Innen mm	außen mm
DHCAW-20-2M-C	2414	210	DWSK20	Ø 210	243x243
DHCAW-20-4M-C	1434	210	DWSK20	Ø 210	243x243
DHCAW-25-2M-C	2095	280	DWSK30	Ø 310	346x346
DHCAW-25-4M-C	1399	280	DWSK30	Ø 310	346x346
DHCAW-30-2M	2730	326	DWSK35	Ø 360	397x397
DHCAW-30-4M	1386	325	DWSK35	Ø 360	397x397
DHCAW-31-4M	1228	345	DSWK35	Ø 360	397x397
DHCAW-35-4M-K	1070	390	DWSK40	Ø 422	462x462
DHCAW-40-4M	1350	420	DWSK40	Ø 422	462x462
DHCAW-45-4M	1393	480	DWSK50	Ø 505	548x548
DHCAW-50-4M	1237	531	DWSK55	563x563	603x603
DHCAW-56-4M	1424	589	DWSK65	655x655	696x696
DHCAW-63-6M	916	664	DWSK71	720x720	760x760
DHCAW-71-6M	852	763	DWSK80	800x800	840x840

Wandventilator	Drehzahl	Wand- einschub	Abluftklappe quadratisch		
	U/min	Ø mm	Modell	Innen mm	außen mm
DHCAW-31-4T	1364	345	DSWK35	Ø 360	397x397
DHCAW-35-4T	1366	417	DWSK40	Ø 422	462x462
DHCAW-40-4T	1372	420	DWSK40	Ø 422	462x462
DHCAW-45-4T	1353	480	DWSK50	Ø 505	548x548
DHCAW-50-4T	1290	531	DWSK55	563x563	603x603
DHCAW-56-4T	1283	589	DWSK65	655x655	696x696
DHCAW-63-4T	1353	664	DWSK71	720x720	760x760
DHCAW-63-6T	903	664	DWSK71	720x720	760x760
DHCAW-71-4T	1302	763	DWSK80	800x800	840x840
DHCAW-71-6T	914	763	DWSK80	800x800	840x840
DHCAW-80-6T	833	869	DWSK90	900x900	940x940
DHCAW-90-6T	884	922	DWSK100	1000x1000	1040x1040
DHCAW-100-6T	823	1016	DWSK110	1100x1100	1140x1140

Technische Änderungen vorbehalten