

Rohrventilator DHPX DHPX/SEC Riementrieb

Axial-Rohrventilatoren DHPX und DHPX/SEC mit außerhalb vom Luftstrom befindlichem Elektromotor für belastete Abluft. Die Antriebseinheit ist dank beweglichem Deckel aufklappbar.

Die Type DHPX/SEC wird in verstärkter Ausführung und zusätzlich mit externer Schmiermöglichkeit der Lager geliefert.



Ventilator:

- Zylindrisches Gehäuse aus Stahlblech mit drehbarem Deckel.
- Laufräder aus Aluminiumguss.
- Dichtes Antriebsaggregat (IP-66) mit Doppellippendichtung.
- Förderrichtung Motor-Laufrad.
- Temperatur der beförderten Luft: -25 °C ... +120 °C (kurzzeitig)

Motor:

- Motoren der Effizienzklasse IE3 für Leistungen $\geq 0,75$ kW
- Motoren der Klasse F mit Kugellager, Schutzart IP55.
- Drehstrommotoren 230/400 V 50 Hz (bis 4 kW) und 400/690 V 50 Hz (Leistungen über 4 kW)

Ausführung:

- Korrosionsbeständig mit Polymer-Polyesterharz 190 °C nach Entfetten mit nanotechnischer Behandlung, phosphatfrei.

Auf Anfrage:

- Lüftrichtung Laufrad-Motor.
- 100 %ig umkehrbare Laufräder.
- Spezialwicklungen für verschiedene Spannungen.
- ATEX-Zertifizierung Kategorie 2 (siehe Serie DHPX/ATEX).

Zubehör

- Schutzgitter
- Gegenflansch, Rohrstützen
- Flexible Rohranschluss-Verbinder / Flansche
- Montagekonsole
- Schalldämpfer



Modell	Drehzahl (U/min)	Nennstrom			Nennleistung (kW)	Luftmenge max. (m³/h)	Pressung max. (Pa)	Schalldruck in Abstand 1m (dB(A))	Gewicht ca. (kg)
		230V	400V	690V					
		DHPX-35-2T-0.75	2720	2,57					
DHPX-35-4T-0.33	1420	1,66	0,96	0,25	2500	100	63	20	
DHPX-45-4T-0.33	1200	1,66	0,96	0,25	6300	140	72	32	
DHPX-45-4T-0.5	1420	2,02	1,17	0,37	6600	180	73	36	
DHPX-50-4T-0.75	1310	2,92	1,69	0,55	9000	180	75	33	
DHPX-50-4T-1	1500	2,82	1,62	0,75	10800	180	76	35	
DHPX-56-4T-0.75	1380	2,92	1,69	0,55	11300	180	78	36	
DHPX-56-4T-1	1420	2,82	1,62	0,75	12200	190	79	37	
DHPX-56-4T-1.5	1420	4,07	2,34	1,1	14500	210	81	43	
DHPX-63-4T-1.5	1300	4,07	2,34	1,1	16000	150	82	63	
DHPX-63-4T-2	1420	5,41	3,11	1,5	17500	210	86	71	
DHPX-71-4T-1.5	1200	4,07	2,34	1,1	20300	200	86	78	
DHPX-71-4T-2	1350	5,41	3,11	1,5	22500	220	87	85	
DHPX-71-4T-3	1450	7,93	4,56	2,2	24000	220	89	86	
DHPX-80-4T-4	1350	10,7	6,15	3	32000	290	92	105	
DHPX-80-4T-5.5	1450	13,9	8	4	40500	330	92	108	
DHPX-90-4T-5.5	1280	13,9	8	4	44000	450	98	120	
DHPX-90-4T-7.5	1400		10,3	5,97	5,5	51000	450	100	155
DHPX-100-4T-10	1450		13,9	8,06	7,5	63000	500	104	175
DHPX-100-4T-15	1450		20,9	12,1	11	68000	500	105	206

Modell	Drehzahl (U/min)	Nennstrom			Nennleistung (kW)	Luftmenge max. (m³/h)	Pressung max. (Pa)	Schalldruck in Abstand 1m (dB(A))	Gewicht ca. (kg)
		230V	400V	690V					
		DHPX/SEC-63-4T-1.5	1455	4,07					
DHPX/SEC-63-4T-2	1450	5,48	3,15	1,5	19300	190	79	69	
DHPX/SEC-63-4T-3	1435	7,93	4,56	2,2	21700	190	90	78	
DHPX/SEC-63-4T-4	1440	10,7	6,15	3	24250	190	91	84	
DHPX/SEC-71-4T-1.5	1455	4,07	2,34	1,1	18100	200	91	81	
DHPX/SEC-71-4T-2	1450	5,48	3,15	1,5	20900	200	92	85	
DHPX/SEC-71-4T-3	1435	7,93	4,56	2,2	25100	200	93	93	
DHPX/SEC-71-4T-4	1440	10,7	6,15	3	27500	200	95	99	
DHPX/SEC-80-4T-4	1440	10,7	6,15	3	27900	380	91	112	
DHPX/SEC-80-4T-5.5	1450	13,9	8	4	32750	400	92	118	
DHPX/SEC-90-4T-4	1440	10,7	6,15	3	33600	400	95	123	
DHPX/SEC-90-4T-5.5	1450	13,9	8	4	38900	400	97	129	
DHPX/SEC-90-4T-7.5	1465		10,3	5,97	5,5	44150	430	98	154
DHPX/SEC-90-4T-10	1465		13,9	8,06	7,5	48600	450	99	163
DHPX/SEC-100-4T-7.5	1465		10,3	5,97	5,5	46850	450	101	164
DHPX/SEC-100-4T-10	1465		13,9	8,06	7,5	54900	500	102	173
DHPX/SEC-100-4T-15	1470		21,4	12,4	11	63200	550	103	218
DHPX/SEC-100-4T-20	1465		27,9	15	72900	500	104	218	

Abmessungen

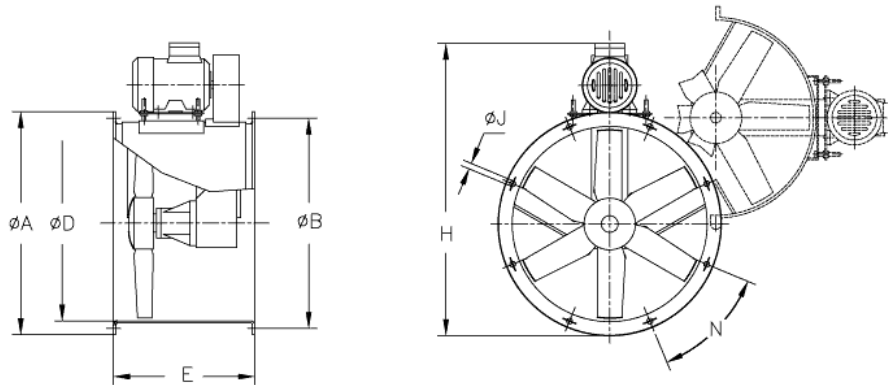

Modell	ØA	ØB	ØD	E	F	ØJ	N
DHPX-35-2T-0,75	425	395	355	380	606	10	8x45°
DHPX-35-4T-0,33	425	395	355	380	609	10	8x45°
DHPX-45-4T-0,33	540	500	460	420	740	12	8x45°
DHPX-45-4T-0,50	540	500	460	420	728	12	8x45°
DHPX-50-4T-0,75	600	560	512	420	803	12	12x30°
DHPX-50-4T-1	600	560	512	420	803	12	12x30°
DHPX-56-4T-0,75	660	620	560	450	848	12	12x30°
DHPX-56-4T-1	660	620	560	450	848	12	12x30°
DHPX-56-4T-1,5	660	620	560	450	870	12	12x30°
DHPX-63-4T-1,5	730	690	640	500	950	12	12x30°
DHPX-63-4T-2	730	690	640	500	950	12	12x30°
DHPX-71-4T-1,5	810	770	710	550	1017	12	16x22°30'
DHPX-71-4T-2	810	770	710	550	1017	12	16x22°30'
DHPX-71-4T-3	810	770	710	550	1035	12	16x22°30'
DHPX-80-4T-4	900	860	800	600	1173	12	16x22°30'
DHPX-80-4T-5,5	900	860	800	600	1200	12	16x22°30'
DHPX-90-4T-5,5	1015	970	900	650	1320	15	16x22°30'
DHPX-90-4T-7,5	1015	970	900	650	1320	15	16x22°30'
DHPX-100-4T-10	1115	1070	1000	750	1483	15	16x22°30'
DHPX-100-4T-15	1115	1070	1000	750	1513	15	16x22°30'

Modell	ØA	ØB	ØD	E	F	ØJ	N
DHPX/SEC-63-4T-1.5	730	690	640	500	943	12	12x30°
DHPX/SEC-63-4T-2	730	690	640	500	943	12	12x30°
DHPX/SEC-63-4T-3	730	690	640	500	963	12	12x30°
DHPX/SEC-63-4T-4	730	690	640	500	963	12	12x30°
DHPX/SEC-71-4T-1.5	810	770	710	550	1022	12	16x22°30'
DHPX/SEC-71-4T-2	810	770	710	550	1022	12	16x22°30'
DHPX/SEC-71-4T-3	810	770	710	550	1048	12	16x22°30'
DHPX/SEC-71-4T-4	810	770	710	550	1048	12	16x22°30'
DHPX/SEC-80-4T-4	900	860	800	600	1165	12	16x22°30'
DHPX/SEC-80-4T-5.5	900	860	800	600	1186	12	16x22°30'
DHPX/SEC-90-4T-4	1015	970	900	650	1255	15	16x22°30'
DHPX/SEC-90-4T-5.5	1015	970	900	650	1292	15	16x22°30'
DHPX/SEC-90-4T-7.5	1015	970	900	650	1338	15	16x22°30'
DHPX/SEC-90-4T-10	1015	970	900	650	1338	15	16x22°30'
DHPX/SEC-100-4T-7.5	1115	1070	1000	750	1453	15	16x22°30'
DHPX/SEC-100-4T-10	1115	1070	1000	750	1453	15	16x22°30'
DHPX/SEC-100-4T-15	1115	1070	1000	750	1525	15	16x22°30'
DHPX/SEC-100-4T-20	1115	1070	1000	750	1525	15	16x22°30'

Akustik

Spektrum des Schalleistungspegels Lw(A) in dB(A) Frequenzband in [Hz]

Modell	63	125	250	500	1000	2000	4000	8000
DHPX-35-2T-0,75	48	63	82	81	82	81	76	67
DHPX-35-4T-0,33	31	46	65	64	65	64	59	50
DHPX-45-4T-0,33	40	55	74	73	74	73	68	59
DHPX-45-4T-0,50	41	56	75	74	75	74	69	60
DHPX-50-4T-0,75	44	58	77	77	78	76	72	63
DHPX-50-4T-1	45	59	78	78	79	77	73	64
DHPX-56-4T-075	47	67	75	80	82	79	72	61
DHPX-56-4T-1	48	68	76	81	83	80	73	62
DHPX-56-4T-1,5	57	68	78	84	85	80	69	65
DHPX-63-4T-1,5	51	71	79	84	86	83	76	65
DHPX-63-4T-2	62	73	83	89	90	85	74	70
DHPX-71-4T-1,5	55	75	83	88	90	87	80	69
DHPX-74-4T-2	56	76	84	89	91	88	81	70
DHPX-71-4T-3	65	76	86	92	93	88	77	73
DHPX-80-4T-4	61	81	89	94	96	93	86	75
DHPX-80-4T-5,5	68	79	89	95	96	91	80	76
DHPX-90-4T-5,5	67	88	95	100	103	99	92	81
DHPX-90-4T-7,5	69	90	97	102	105	101	94	83
DHPX-100-4T-10	73	93	101	106	108	105	98	87
DHPX-100-4T-15	74	94	102	107	109	106	99	88

Modell	63	125	250	500	1000	2000	4000	8000
DHPX/SEC-63-4T-1.5	48	68	76	81	83	80	73	65
DHPX/SEC-63-4T-2	52	68	76	81	83	80	73	66
DHPX/SEC-63-4T-3	53	70	78	83	85	82	77	67
DHPX/SEC-63-4T-4	54	71	79	84	86	83	78	68
DHPX/SEC-71-4T-1.5	54	74	82	87	89	86	79	69
DHPX/SEC-71-4T-2	53	73	81	86	88	85	78	70
DHPX/SEC-71-4T-3	58	72	80	85	87	84	77	71
DHPX/SEC-71-4T-4	59	73	81	86	88	85	78	72
DHPX/SEC-80-4T-4	56	76	84	89	91	88	81	74
DHPX/SEC-80-4T-5.5	56	76	84	89	91	88	81	70
DHPX/SEC-90-4T-4	61	82	89	94	97	93	86	79
DHPX/SEC-90-4T-5.5	60	81	88	93	96	92	85	74
DHPX/SEC-90-4T-7.5	59	80	87	92	95	91	84	73
DHPX/SEC-90-4T-10	58	79	86	91	94	90	83	72
DHPX/SEC-100-4T-7.5	64	84	92	97	99	96	89	78
DHPX/SEC-100-4T-10	62	82	90	95	97	94	87	76
DHPX/SEC-100-4T-15	61	81	89	94	96	93	86	75
DHPX/SEC-100-4T-20	63	83	91	96	98	95	88	77

Kennlinien DHPX für Luftdichte 1,2 kg/m³

DHPX-35-2T

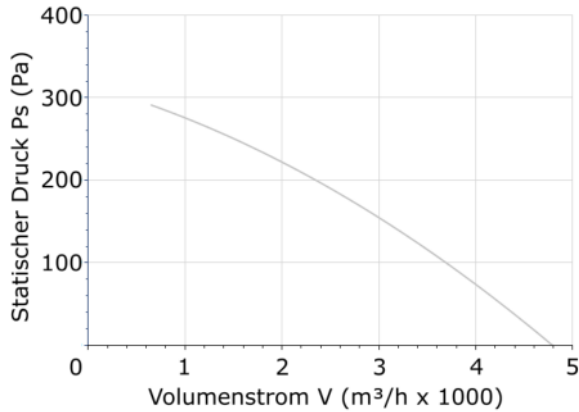

DHPX-35-4T

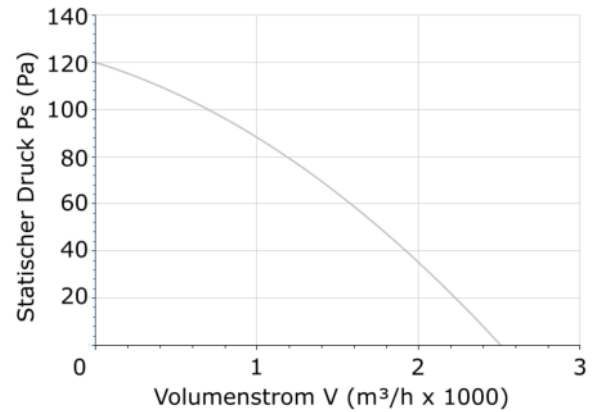

DHPX-45-4T-0,33

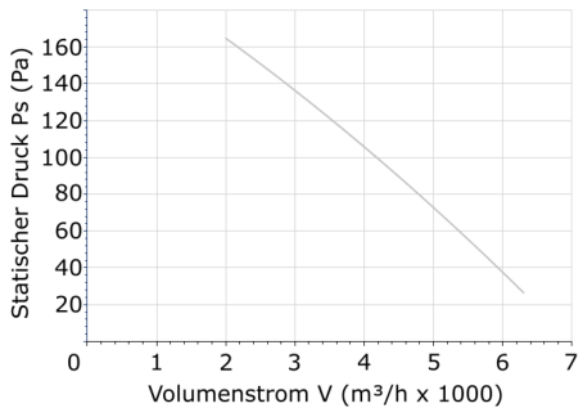

DHPX-45-4T-0,5

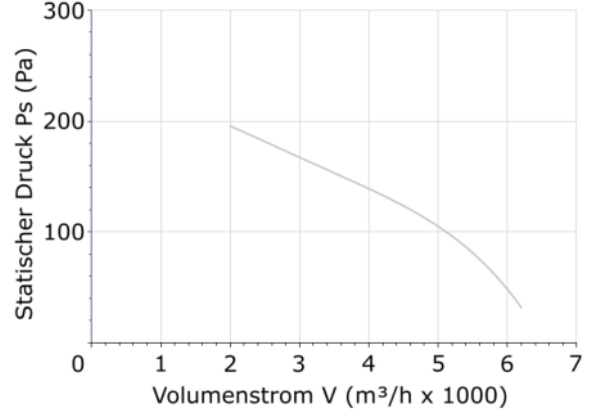

DHPX-50-4T-0,75

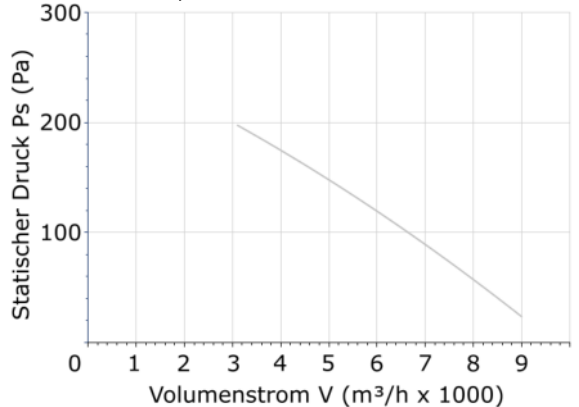

DHPX-50-4T-1

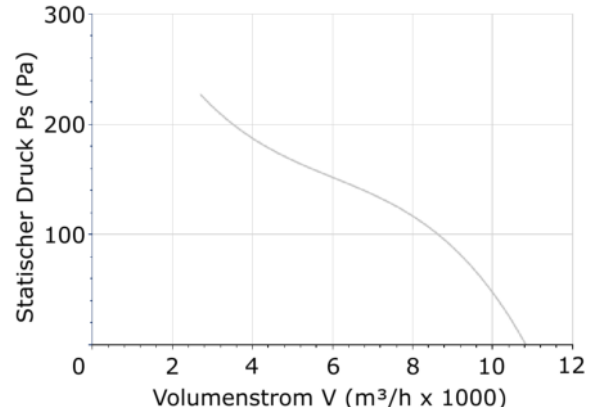

Kennlinien DHPX für Luftdichte 1,2 kg/m³

DHPX-56-4T-0,75

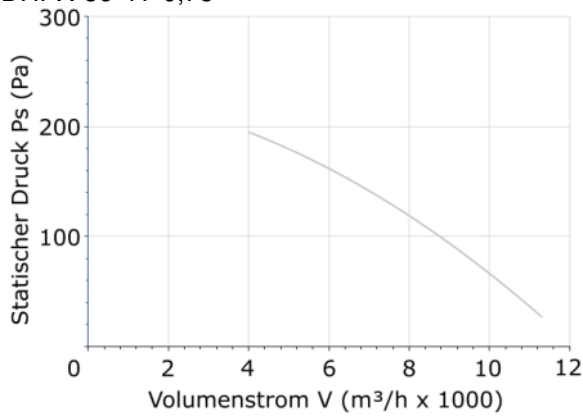

DHPX-56-4T-1

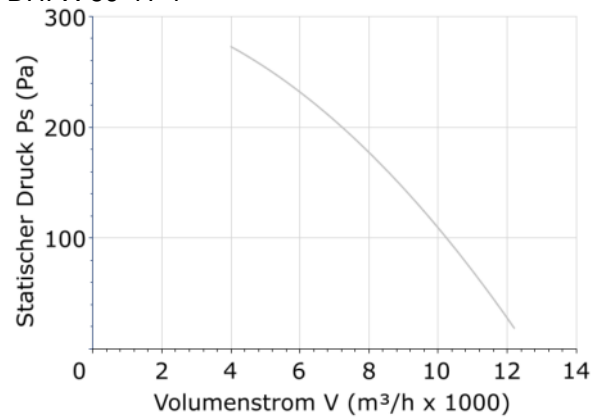

DHPX-56-4T-1,5

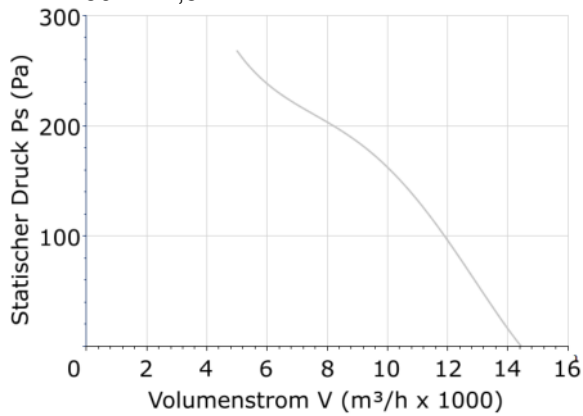

DHPX-63-4T-1,5

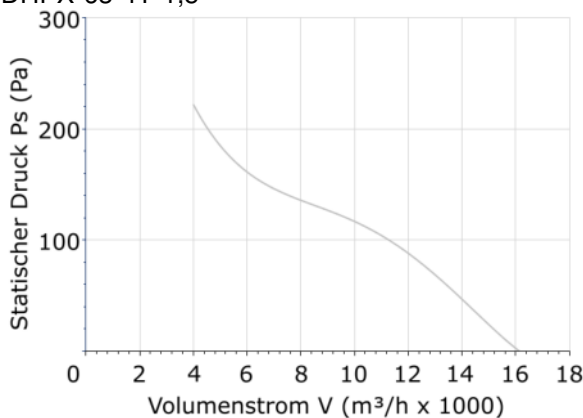

DHPX-63-4T-2

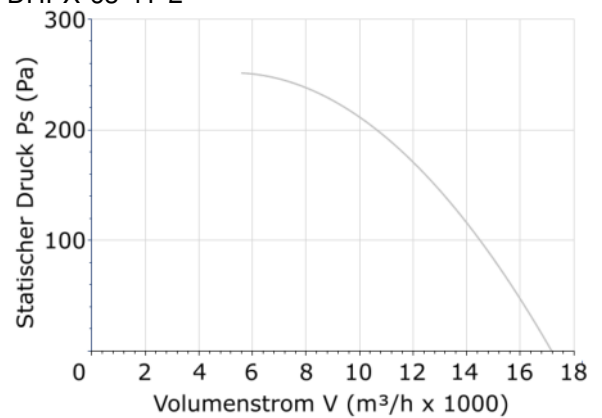

Kennlinien DHPX für Luftdichte 1,2 kg/m³

DHPX-71-4T-1,5

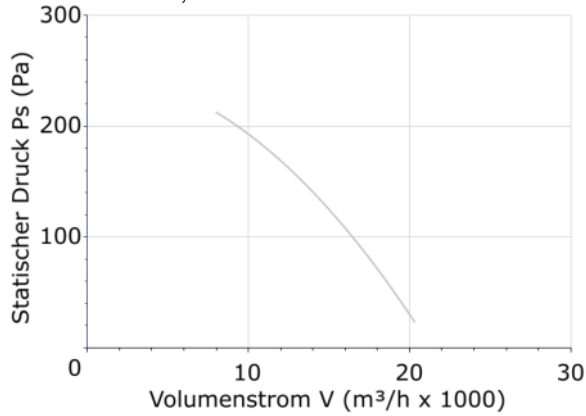

DHPX-71-4T-2

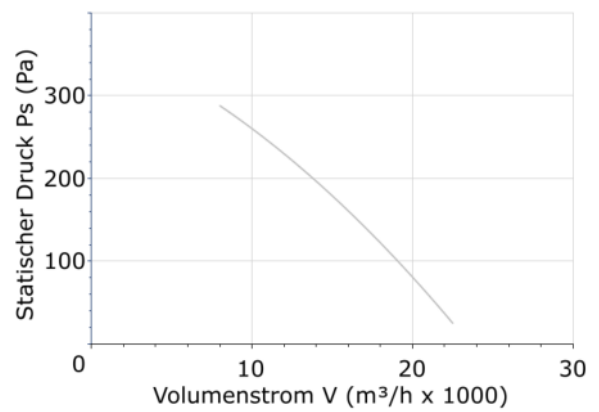

DHPX-71-4T-3

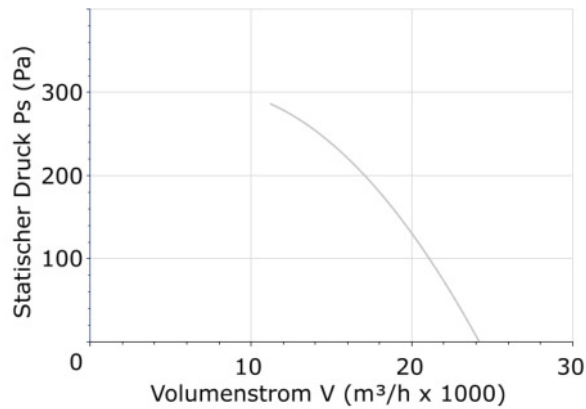

DHPX-80-4T-4

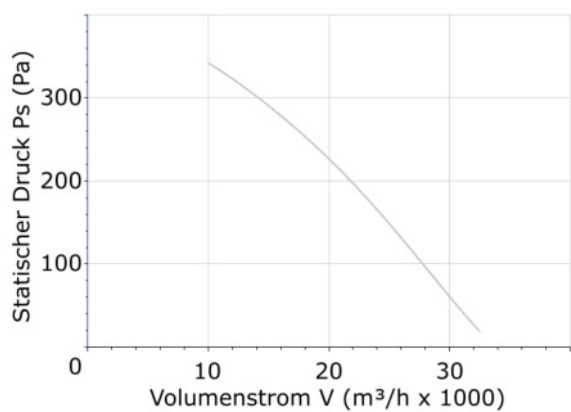

DHPX-80-4T-5,5

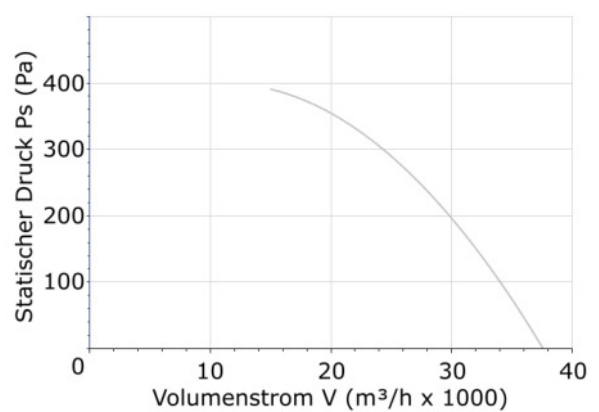

Kennlinien DHPX für Luftdichte 1,2 kg/m³

DHPX-90-4T-5,5

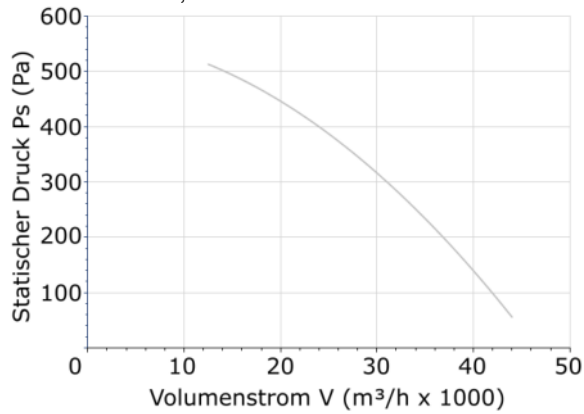

DHPX-90-4T-7,5

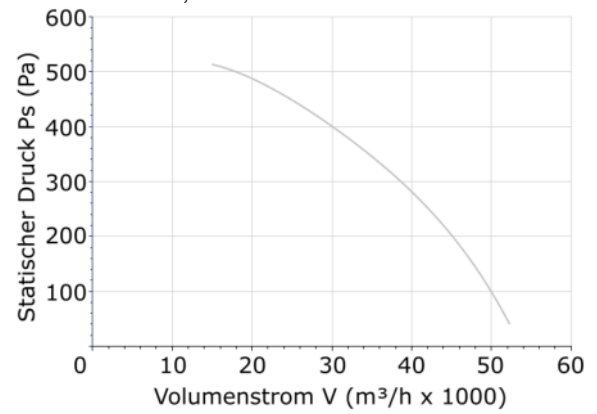

DHPX-100-4T-10

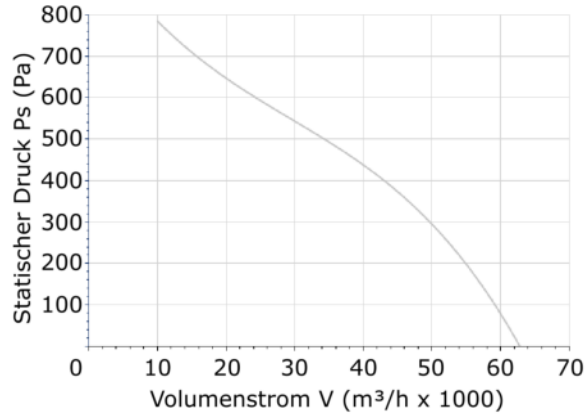

DHPX-100-4T-15

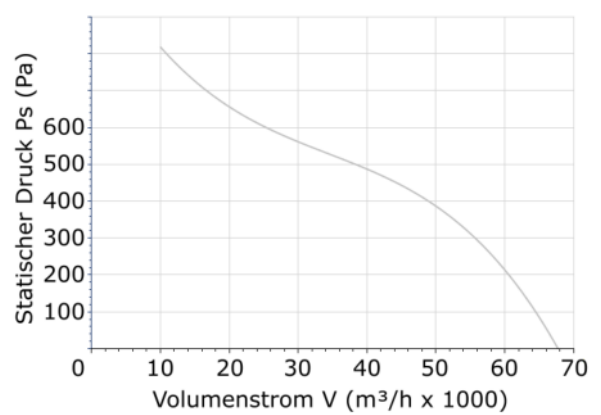

Kennlinien DHPX/SEC für Luftdichte 1,2 kg/m³

DHPX/SEC-63-4T-1,5

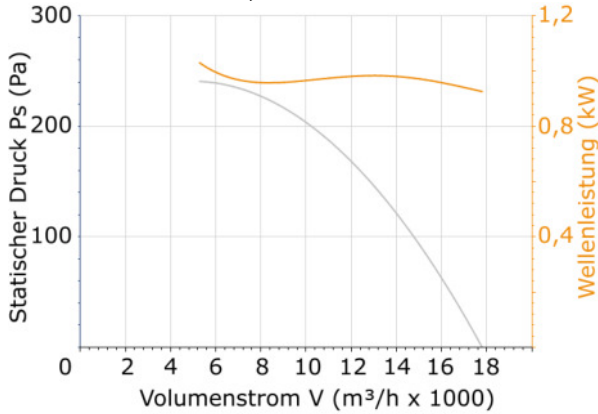

DHPX/SEC-63-4T-2

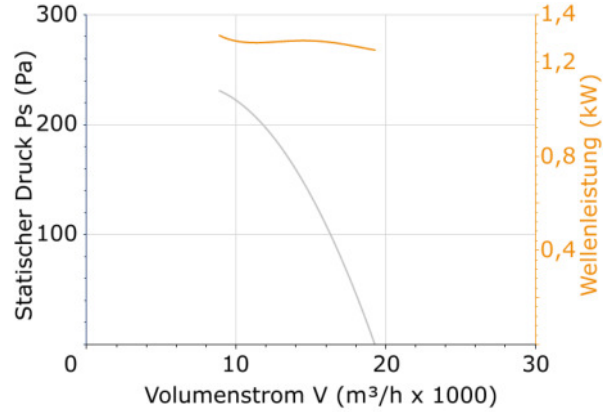

DHPX/SEC-63-4T-3

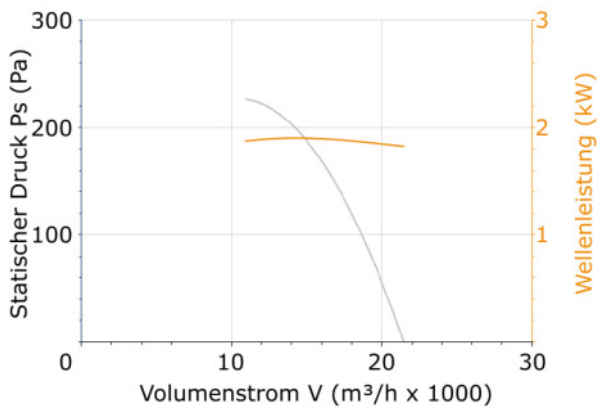

DHPX/SEC-4T-4

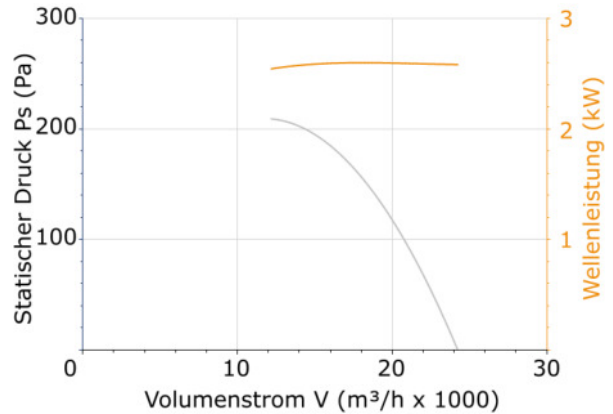

DHPX/SEC-71-4T-1,5

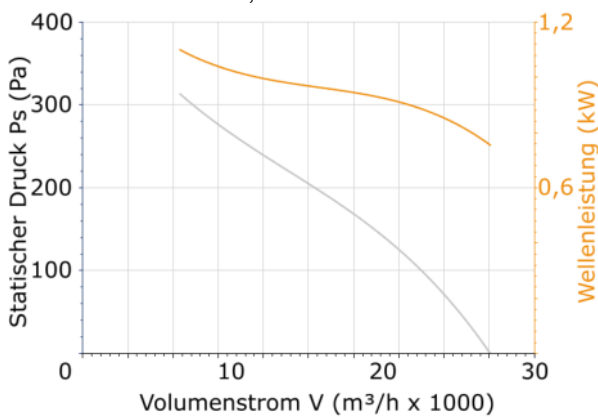

DHPX/SEC-71-4T-2

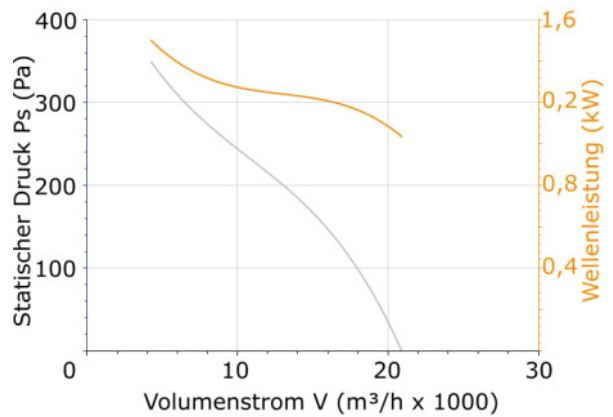

Kennlinien DHPX/SEC für Luftdichte 1,2 kg/m³

DHPX/SEC-71-4T-3

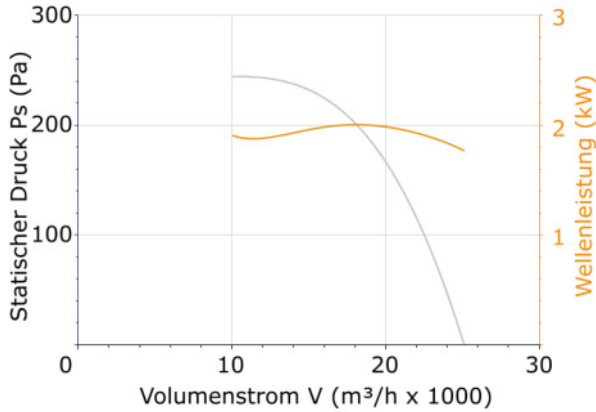

DHPX/SEC-71-4T-4

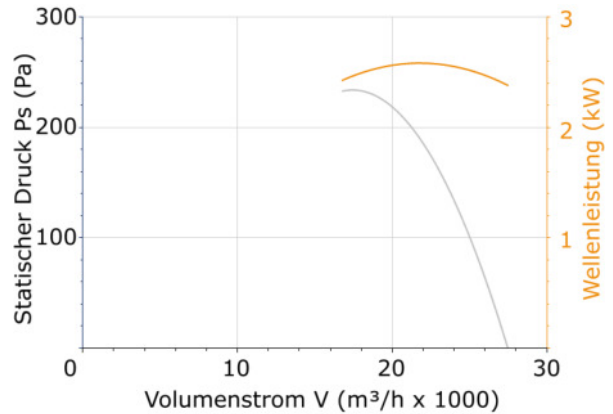

DHPX/SEC-80-4T-4

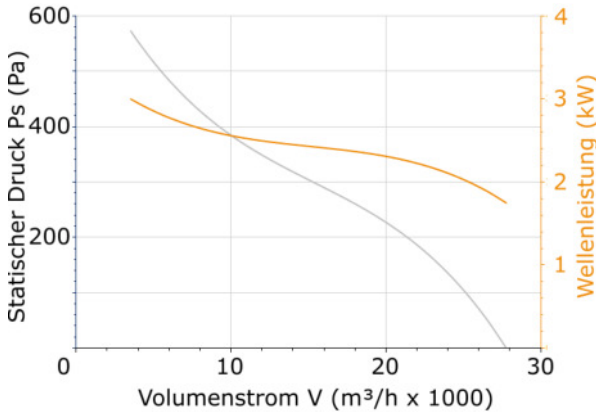

DHPX/SEC-80-4T-5,5

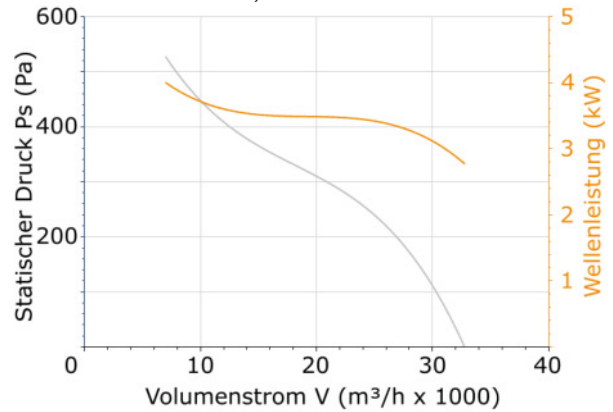

DHPX/SEC-90-4T-4

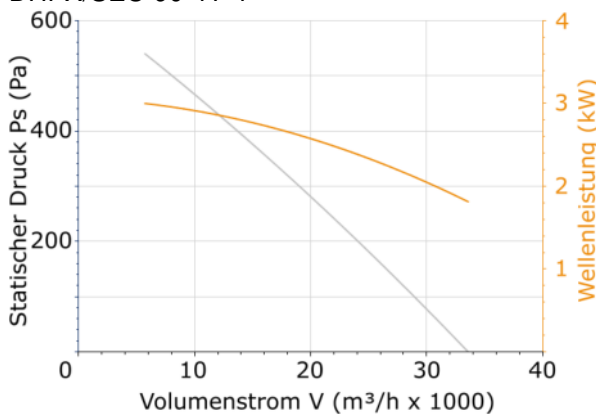

DHPX/SEC-90-4T-5,5

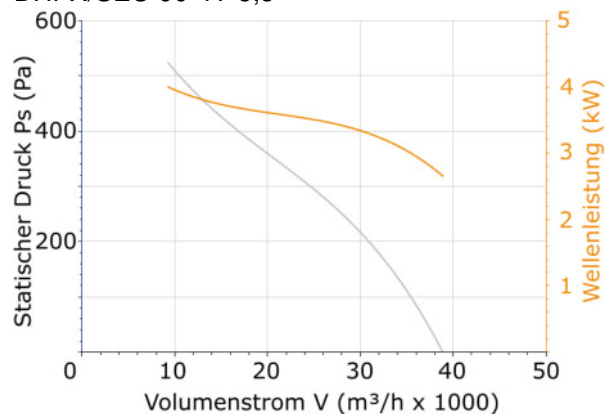

Kennlinien DHPX/SEC für Luftdichte 1,2 kg/m³

DHPX/SEC-90-4T-7,5

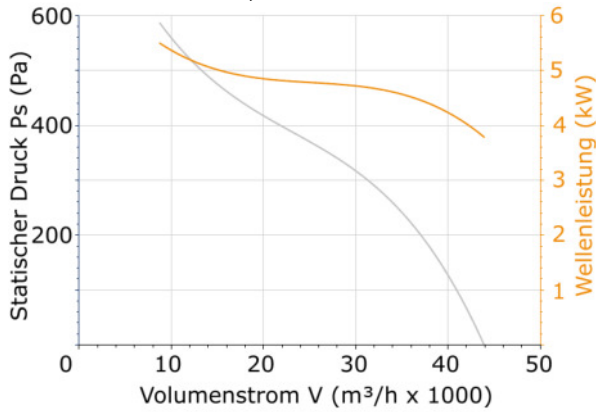

DHPX/SEC-90-4T-10

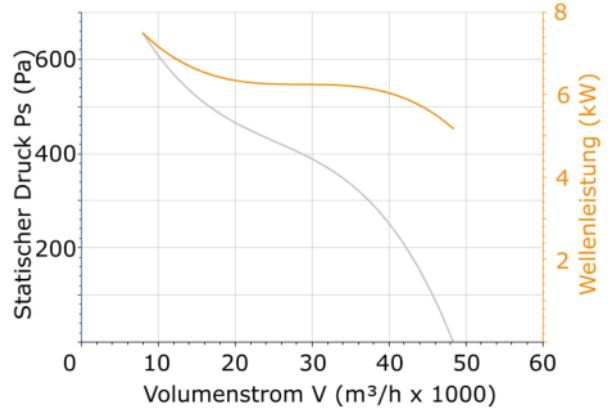

DHPX/SEC-100-4T-7,5

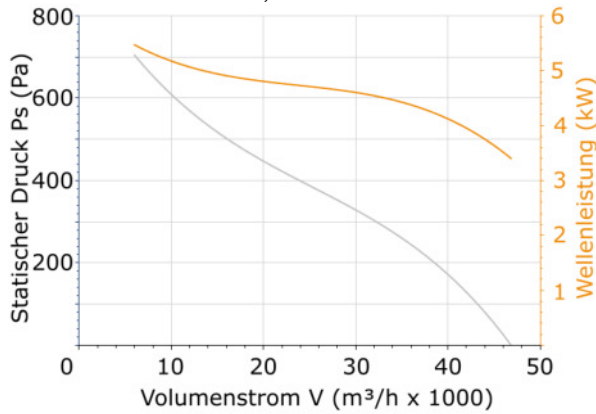

DHPX/SEC-100-4T-10

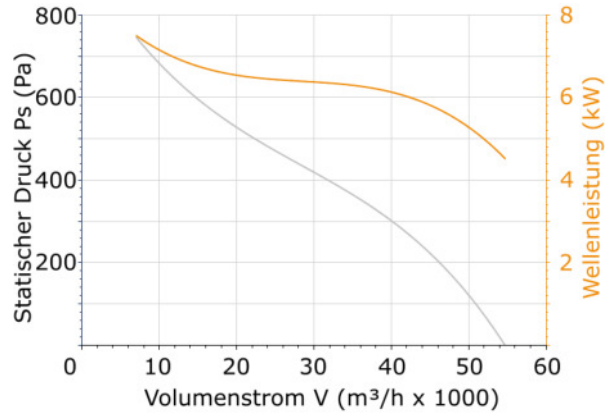

DHPX/SEC-100-4T-15

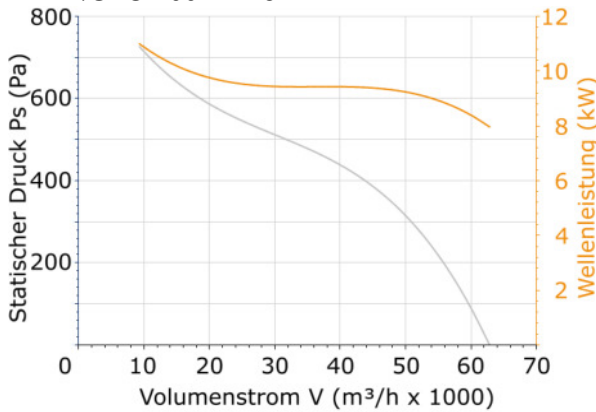

DHPX/SEC-100-4T-20

